



Water Quality Monitoring using a CMOS Integrated CC-ISFET Device

Pawan Whig¹ and Syed Naseem Ahmad²

¹ Research Scholar, Department of Electronics and Communication Engineering, Jamia Millia Islamia, New Delhi-110025 India

² Department of Electronics and Communication Engineering, Jamia Millia Islamia, New Delhi-110025 India

Abstract

This study presents a performance analysis of low power CMOS Integrated “Current Conveyor Ion Sensitive Field Effect transistor” (CC-ISFET). The study’s main focus is on simulation of power and performance analysis of ISFET device, which is used for water quality monitoring. This approach can improve calibration of device to a fairly wide range without the use of a high speed digital processor. The conventional devices generally used, consume high power and are not stable with temperature and frequency variations for long term monitoring. The conventional device [1] has a drawback of low value of slew rate, high power consumption, and non linear characteristics but in this novel design, the device exhibits a better slew rate, piece- wise linear characteristics, and seen consuming low power of the order of $5.7\mu\text{W}$. The functionality of the circuit is tested using Tanner simulator version 15 for a 70nm CMOS process model. Very high speed integrated circuit Hardware description language (VHDL) code for the same scheme is simulated on Xilinx ISE 10.1 and various simulation results are obtained. The proposed circuit reduces total power consumption per cycle, increases speed of operation, fairly linear and is simple to implement. This device has a simple architecture, and hence is very suitable for water quality monitoring applications.

Keywords: *Slew rate, Calibration, Simulation, Monitoring, Ion Sensitive Field Effect Transistor, Simulation, Current Conveyors, Frequency compensation, Low power.*

Introduction

Monitoring the pH of water resources for water pollution is a typical and necessary task in today’s overdeveloped scenario. The normal pH for surface water systems is 6.5-8.5 and for ground water system 6-8. Water with low pH is acidic, corrosive and contains several toxic materials which are very dangerous for health, but the water having pH more than 8.5 is called hard water which does not contain harmful materials but the long use of such kind of water can cause many problems [2]. With the invention of ISFET [3] there has been a rapid development of pH Measurement Instruments [4]. With the further advancement of semiconductor technology ISFET emerged as a standard device. In spite of the fact that ISFET Sensor has been developed 30 years ago [5], several drawback of ISFET sensor remained unsolved, such as phenomena of fluctuation with time and temperature variations. This causes in drift in the pH values, and result in poor and slow response of the device. The second phenomenon is pH dependent Temperature Coefficient and non linear temperature dependent mobility in MOSFETS of ISFET device. Also it was observed that in ISFET drift rate has an exponential incremental tendency with pH values as well as Temperature. In Urban water supply system, the water quality determining indices such as pH value and turbidity are monitored continuously. When the indices exceed the limiting value, the system will effectively handle the treatment against deterioration ensuring the safety of water. Water is vital for all known forms of life. Many research works have contributed to design water quality measuring devices. But it has always been a challenge to find a precise and accurate device for monitoring the quality of water. The concept of p[H] was first introduced by Danish chemist Soren Peder Lauritz Sorensen at the Carlsberg Laboratory in 1909 and revised to the modern pH in 1924 after it became apparent that electromotive force in cells depended on activity rather than concentration of hydrogen ions. The pH is a measure of the acidity or basicity of an aqueous solution. The use of micro sensors for in field monitoring of environmental parameters is gaining interest due to their advantages over conventional sensors. In the field of micro sensors for environmental applications, Ion Selective Field Effect Transistors (ISFETs) has proved to be of special application. They are particularly helpful for measuring pH and other ions in small volumes and they can be integrated in compact flow cells for continuous measurements and monitoring [6]. Pure water is said to be neutral, with a pH close to 7.0 at 25°C (77°F). Solutions with a pH less than seven (7) are said to be acidic and

solutions with a pH greater than seven (7) are basic or alkaline.

1.1 ISFET

An ISFET is an ion-sensitive field-effect transistor which has a property of measuring ion concentrations in solution; when the ion concentration (such as H^+) changes, the current through the transistor will change accordingly. Here, the solution is used as the gate electrode. A voltage between substrate and oxide surfaces arises due to an ions' sheath. The ISFET has the similar structure as that of the MOSFET except that the poly gate of MOSFET is removed from the silicon surface and is replaced with a reference electrode inserted inside the solution, which is directly in contact with the hydrogen ion (H^+) sensitive gate electrode [7] The Sub circuit block of ISFET macro model is shown in Figure 1.

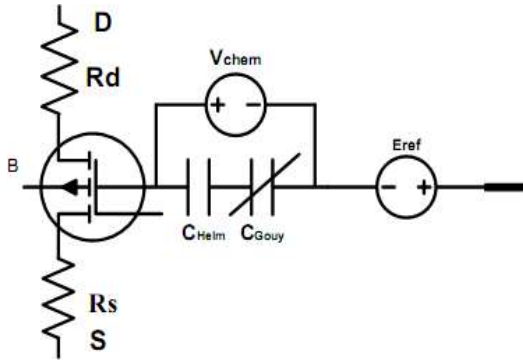

Fig. 1. Sub circuit block of ISFET macro model.

At the interface between gate insulator and the solution, there is an electric potential difference that depends on the concentration of H^+ of the solution, or so called, pH value. The variation of this potential caused by the pH variation will lead to modulation of the drain current. As a result, the I_d - V_{gs} transfer characteristic of the ISFET, working in triode region, can be observed similar with that of MOSFET:

$$I_{ds} = \frac{\mu C_{ox} W}{L} \left[(V_{gs} - V_{th_isfet}) V_{ds} - \frac{1}{2} (V_{ds})^2 \right] \quad (1)$$

The threshold voltage is only different in case of MOSFET. In ISFET, defining the metal connection of the reference electrode as a remote gate, the threshold voltage is given by:

$$V_{th (ISFET)} = E_{Ref} + \Delta\phi^{lj} - \Psi_{col} + \chi^{sol} + \frac{-\phi_s}{q} - \frac{Q_{ox} + Q_{ss}}{C_{ox}} + \gamma [2\phi_f]^{1/2} + 2\phi_f \quad (2)$$

Where E_{Ref} is Potential of reference electrode, $\Delta\phi^{lj}$ is the potential drop between the reference electrode and the solution, which typically has a value of 3mV [8]. Ψ_{col} is the potential which is pH-independent; it can be viewed as a common-mode input signal for an ISFET interface circuit in any pH buffer solution and can be nullified during system calibration and measurement procedures with a typical value of 50 mV [9]. χ^{sol} is the surface dipole potential of the solvent being independent of pH., the terms in the parentheses are most the same as that of the MOSFET threshold voltage except that of absence of the gate metal function. The other terms in above equation are a group of chemical potential, among which the only chemical input parameter shown has to be a function of solution pH value. This chemical dependent characteristic has already been explained by the Hal and Eijkel's theory which is elaborated using the general accepted site-binding model and the Gouy-Chapman-Stern model. Conventional water quality monitoring applications are made up of voltage mode circuits (VMC) based on op-amps and OTA's. These applications are suffer from low band widths (BW's) arising due to stray and circuit capacitances. Also the need for low voltage, low power circuits makes these circuits not suitable for water quality monitoring as these circuits required the minimum bias voltage depends on the threshold voltage of the MOSFETs. However, with the advancement in the analog VLSI new analog devices are based on currents are developed called current mode circuits (CMC's). These circuits have a significant advantage of low power, low voltages and can operate over wide dynamic range. These circuits, CMC can offer to the designer large bandwidths, greater linearity, wider dynamic range, simple circuitry and low power consumption. Current feedback op-amps (CFOAs), operational floating conveyors (OFCs) and current conveyors (CCs) etc. are popular CMC configuration and most widely used structure among them is CC-II. Hence, one can use the CC-II for the design prospective.

2.0 Current Conveyor

Current Conveyor (CC-II) has proved to be a versatile analog building block that can be used to implement numerous analog processing applications; it was introduced by Sedra and Smith [10]. The current conveyor is a grounded three-port network represented by the black box as shown in Figure 2. The general Current Conveyor (CC) can be represented by the following input-output matrix relation:

When $a=1$, the first generation current conveyor (commonly denoted CCI) is obtained. For $a=0$, we obtain the second generation current conveyor (commonly denoted CCII). For $a=-1$ we obtain the third generation current conveyor (commonly denoted CCIII). Usually, $b=\pm 1$. The sign of the b parameter determines the conveyor current transfer polarity. Positive b indicates that the CC has a positive current transfer ratio and is denoted by CCI+, CCII+ or CCIII+ while negative b means that it has a negative current transfer ratio and is denoted by CCI-, CCII- or CCIII-

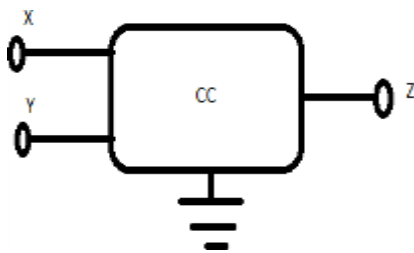

Fig. 2. Block diagram current conveyor

A well-known basic building block is the second generation current conveyor (CCII). Second generation current conveyors are widely used by analog designers. An important attribute of current conveyor is its ability to convey current between two terminals (X and Z) at vastly different impedance levels.

CCISFET

For the integrated sensor, the measurement circuit tracks the threshold voltage (or the flat-band voltage) of the ISFET as the electrolyte pH is varied. A practical solution to integrate the sensor with electronics is to view the ISFET sensor as a circuit component in an integrated circuit rather than as an add-on sensor whose output signal is further processed. In this paper, the ISFET is used as one of the input transistors in the differential stage of the current conveyor as shown in Figure 3. The circuit functions as follows: when the ISFET-Current Conveyor is configured as a voltage follower, the output voltage (V_o) is equal to the input voltage (V_{in}); any difference in threshold voltages and bias currents between the two input transistors at the differential input stage will also appear at the output.

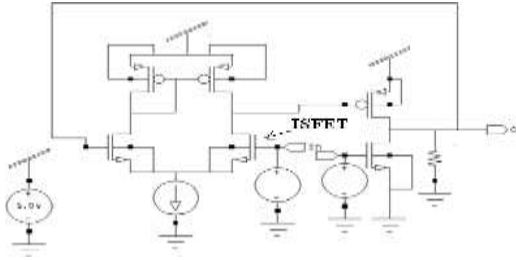

Fig. 3. CCISFET device

3.0 Simulation and Observations

Simulation of a device for water quality monitoring device using CCISFET involving second generation current conveyors have been carried out on Tanner simulator version 15 for a 70nm CMOS process model shown in Figure 4. The output response of the device with respect to the time i.e transient analysis shown in Figure 6 justify the device is highly linear and having better slew rate than the conventional device . The power results obtained when the device is simulated 70nm technology is shown in the appendix at the end of the paper and it is found that the device consumes the average power of 5.7 μ W watts.

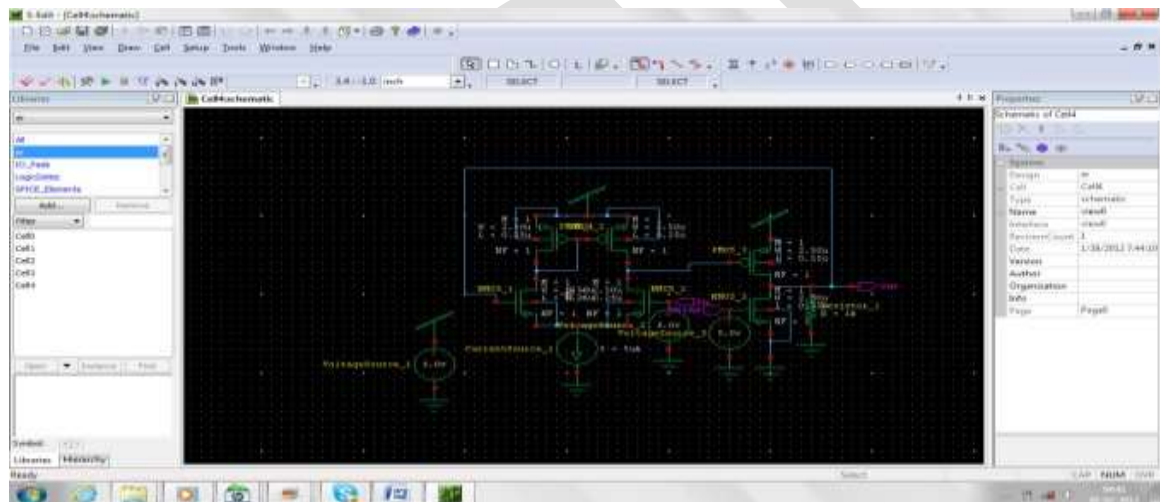

Fig. 4. Circuit diagram of device

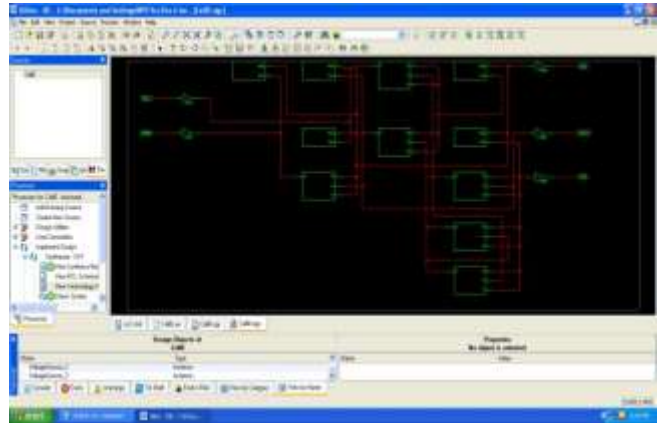
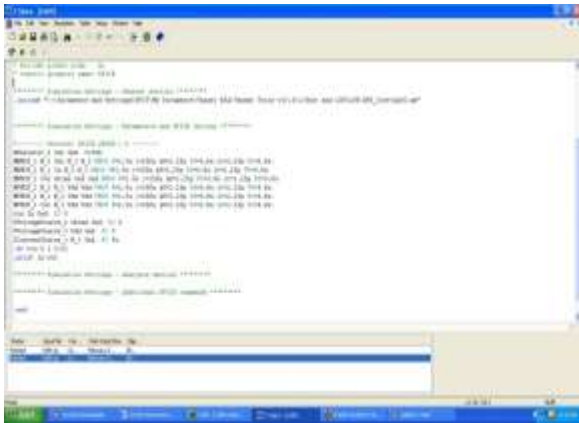

Fig. 5. T-Spice file for the above circuit

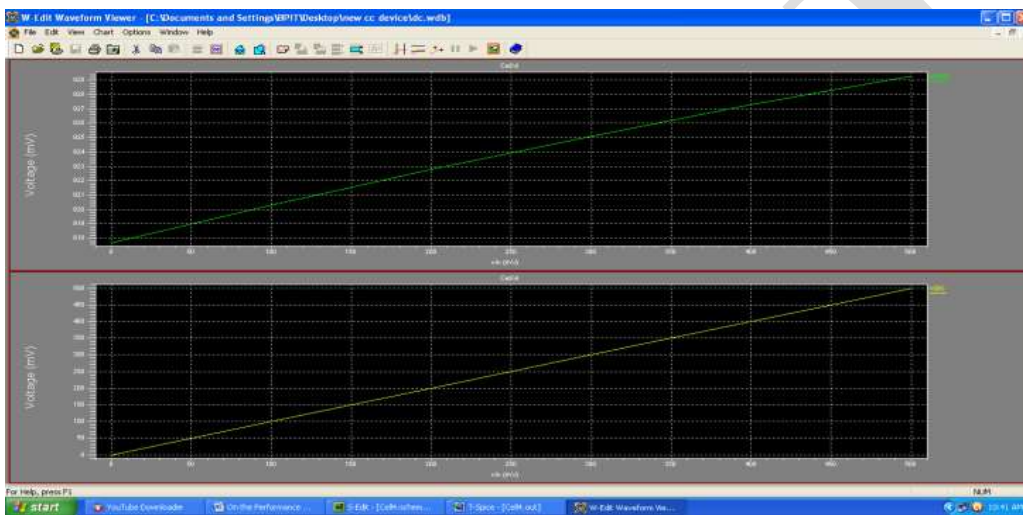

Fig.6.Highly linear output waveform

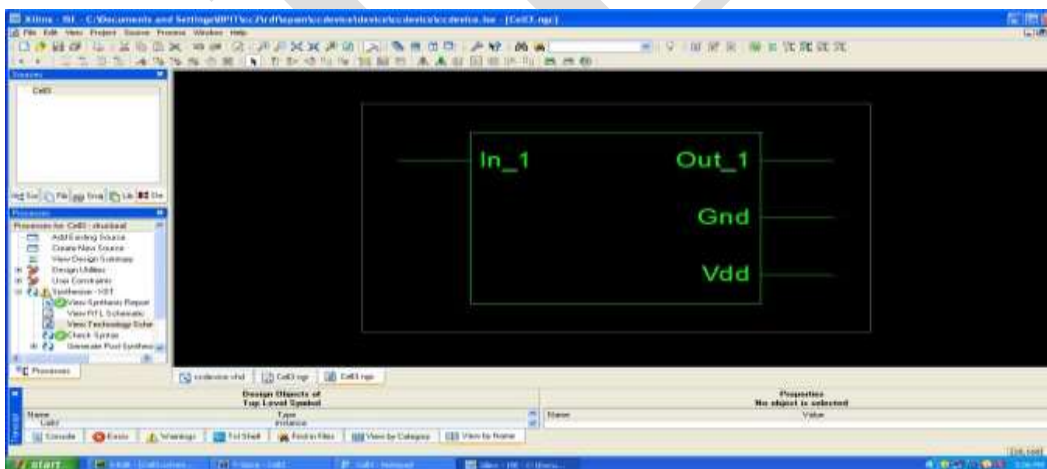

Fig. 7. RTL of CCISFET

Fig. 8. Tecnology Schematic of CC-ISFET

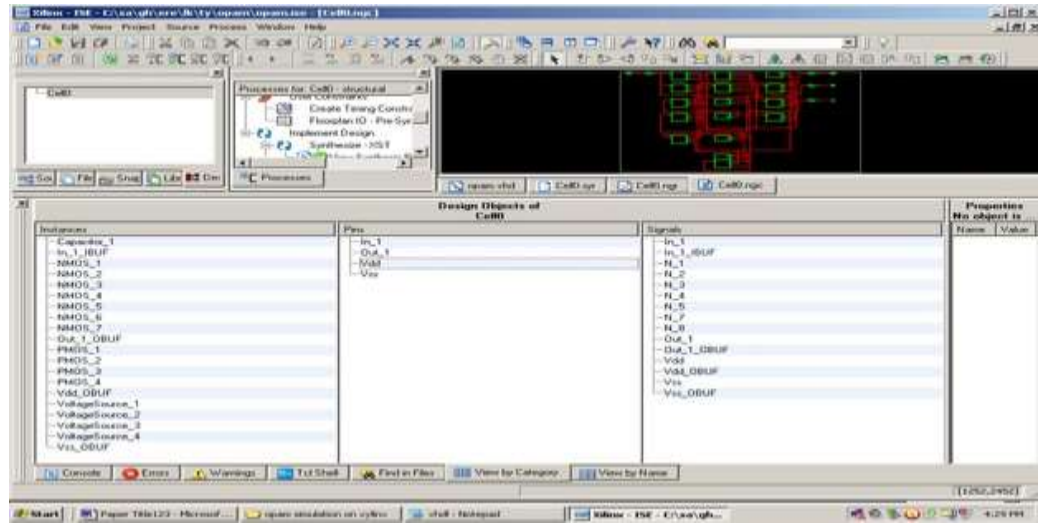

Fig. 9. Objects used in the device

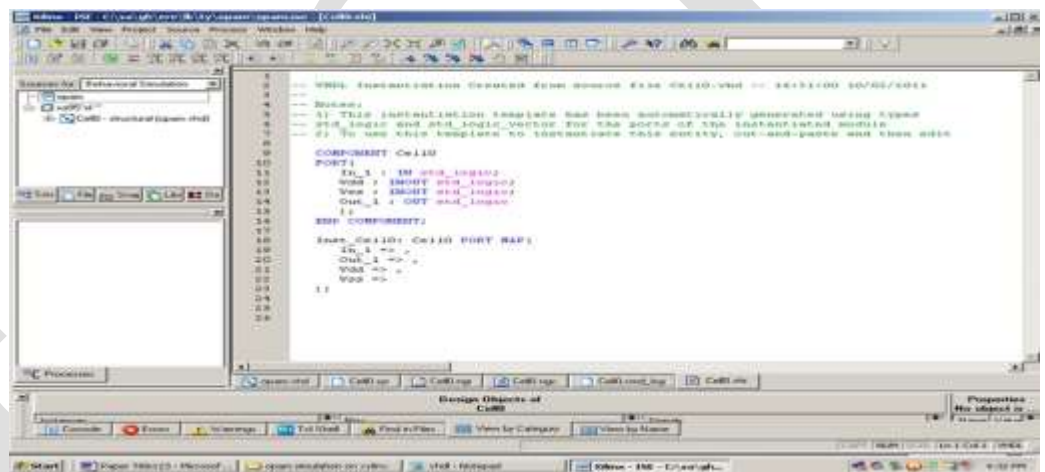

Fig. 10. VHDL instantiation created from source file

Table 1. Transient analysis

Time<s>	v(in1)<V>	v(out)<V>
0.000000e+000	0.0000e+000	0.0000e+000
1.250000e-010	1.2500e-001	9.5606e-002
6.786460e-010	6.7865e-001	5.4378e-001
9.554690e-010	9.5547e-001	7.8071e-001
1.093880e-009	1.0939e+000	8.9976e-001
1.316775e-009	1.3168e+000	1.0922e+000
1.600582e-009	1.6006e+000	1.3394e+000
1.922991e-009	1.9230e+000	1.6229e+000
2.303210e-009	2.3032e+000	1.9608e+000
2.758169e-009	2.7582e+000	2.3703e+000
3.296876e-009	3.2969e+000	2.8694e+000
3.931074e-009	3.9311e+000	3.4780e+000
4.678083e-009	4.6781e+000	4.2192e+000
5.000000e-009	5.0000e+000	4.5821e+000

Table 2. Device process parameters

Process Parameters	
Power Supply (V)	5
Load Regulation	3.93
Line Regulation(m)	0.6
Current range (μA)	1-50
Average Power Consumed (W)	1.126179e-005
Max Power(W)	0.574213e-005

Above Table-1 describe the transient behavior of the input with the output and Table-2 describe the various device process parameters including power supply, Loadregulation, Line Regulation, Current range, Average powerconsumed, Max Power.



Fig. 11.Power Comparison Chart

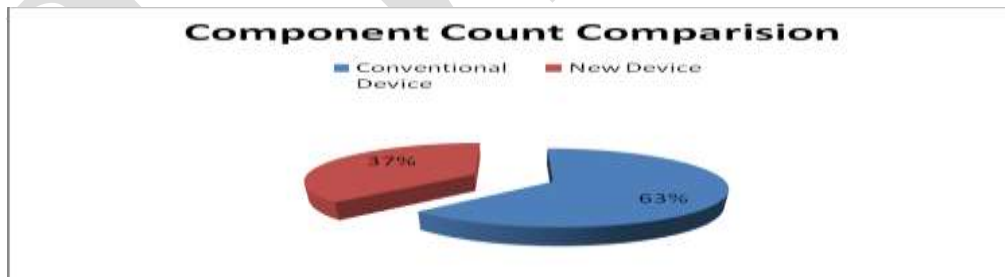

Fig. 12. Component Comparison Chart

Table3: Result analysis of various schemes

Parameters	ConventionalDevice	New Device
Technology	CMOS	CMOS
Power supply(VDD,GND)	5V-0V	5V-0V
No. of Mosfets	27	16
Capacitor	2	2
Current Source	4	3
NMOS	17	10
PMOS	10	6
Resistor	5	5
Voltage Source	4	2
Average powerdissipation (Watts)	1.304338e-005	1.126179e-005
Max power (Watts)	1.635414e-005	0.574213e-005
Min power (Watts)	0000000e-000	0.131296e-005
Stability analysis	Closed loop Stable	Closed loopStable

Inference from table 3:

For the same technology i.e. CMOS technology deployed for all the four analog IC's and the same power supply we arrive at the following comparative results:

- Number of MOSFET's is 27 in Conventional device, 16 in New device, Later deploys 37% of components over 63% used in the previous one shown in Fig. 12.
- Number of capacitors remains constant in both techniques.
- Number of current sources deployed is 4 in Conventional device and 3 in new device.
- Number of n-MOS and p-MOS required are as follows: 17 and 10 for Conventional device, 10 and 6 for new device. From these numbers we can figure out that there is significant saving in terms of Components.
- Number of resistors required for both cases are same.
- Voltage source require for proper operation of the devices are 4 for Conventional device and 2 in new device.
- The average power dissipation in watts is listed for the two cases:
 - Conventional device - 1.304338e-005. New device - 1.126179e-005

Form this we come down to the conclusion that the average power dissipated in the later case is less.

- Maximum power dissipated in watts is listed for the four cases:
 - Conventional device - 1.635414e-005. New device - 0.574213e-005

From this we come down to the conclusion that the maximum power consumption in case of new device is 26% as compared to conventional device which consumes 74%. Hence there is total 48% power saving shown in Fig. 11.

Conclusion

In this novel design, a new device employing second generation current conveyors (CCII's) is proposed. The second-generation current conveyor introduced is a convenient building block that provides a simplified approach to the design of linear analog systems. It also consumes considerably low power of the order of 5.7 μW compared to [1]. There is significant improvement in the slew rate. The output observed in Fig 6 is highly linear. A significant advantage of the proposed design is its simple architecture, and low component count a saving of 26% as compared to [1]. Therefore it is very suitable for water quality monitoring applications. VHDL code for the device is simulated on Xilinx ISE 10.1 software and RTL schematic is shown in fig 7. This study may be extended for further improvements in terms of power and size, besides the wiring and layout characteristics level.

References

- Pawan Whig, S. N. Ahmad, (2011) On the Performance of ISFET- based Device for Water Quality Monitoring. Int'l J. of Communications, Network and System Sciences ISSN 1913-3715, pp:709 -719.
[Online]. Available: <http://www.freedrinkingwater.com/water-education/quality-water-ph.htm>.
- P.Bergveld (1970), *Development of an Ion-sensitive Solid-state Device for Neurophysiologic Measurements*, IEEE Trans. Biomed. Eng. pp: 70-71.
- Cecilia Jimenez-Jorquera, Jahir Orozoo, Antoni Baldi (2010), *ISFET based Microsensors for Environmental Monitoring*, Journal of Sensors ISSN 1424-8220, pp: 61-83.
- P.Bergveld,(2000) "*Thirty years of ISFETOLOGY what happened in the past 30 years and what may happen in the next 30 years*,"Sens.Actuators B, Vol . 88,pp1-20.
- [6] Chang, Y.-H.; Lu, Y.-S.; Hong, Y.-L.; Gwo, S.; Yeh, J. A. (2011); "*Highly Sensitive pH Sensing Using an Indium Nitride Ion-Sensitive Field-Effect Transistor.*" Vol: 11, Issue: 5, pp: 1157-1161.
- D.MWilson,S.Hoyt,J.Janata,K.Booksh,andL.obando,(2001)"*Chemical sensors for portable ,handheld field instruments*,"IEEE Sensors j.,vol.1,no.4,pp256-274.
- S.jamasb,S.D. Collins , and R.L Smith(1998) ,"*A physical model for threshold voltage instability in Si3N4 gate H+ sensitive FETs*,"*IEEE Tran. Electron Devices*, Vol. 45 no. 6 ,pp.1239-1245.
- L.J Bousse,D.Hafeman, and N.Tran(1991),'*Time Dependence of the chemical response of silicon nitride surfaces* ,"Sens. Actuators B,Vol.1,pp.361-367.
- A Sedra, K. A Smith (1970). *second-generation conveyor and its applications*,IEEE Transconductions on Circuit Theory. 1970, CT- 17,pp: 132-134.
- Pawan Whig, S. N. Ahmad, (2011) Performance analysis and frequency Compensation Technique for Low Power Water Quality Monitoring Device Using ISFET Sensor. International Journal of Mobile and Adhoc Network